



# Woltmag & Woltmag M

A reliable, durable water meter for commercial and industrial applications

Woltmag M is a vertical Woltmann water meter designed to provide accurate metering whatever the flow conditions. It is available in sizes DN 50 to 100.

## FEATURES AND BENEFITS

- » Hermetically sealed register (copper can/mineral glass envelope)
- » Accurate metering whatever the flow conditions
- » Interchangeable approved mechanisms without re-calibration
- » Pre-equipped through Cyble as a standard

## Wide Measuring Range

The metrological performance of Woltmag M far exceeds ISO 4064-1:1993 Class B standards.

Significant endurance capability ensures accurate and reliable metering over time across a wide range of applications, such as water distribution networks, bulk billing and process control. All sizes are available with 2 possible nominal flow rates.

## Robustness

Woltmag M features bearings of Cobalttungsten carbide and sapphire, allowing the meter to handle peak flow rates and remain accurate without deteriorating for extended periods.

With its Built-in Flow Straightener, it is less sensitive to waterhammer, shock waves generated by pumps, and other disturbed flow profiles.

Woltmag M also features interchangeable mechanisms for easy field maintenance.

## Reliability

Woltmag M features a direct magnetic transmission between the turbine and the register without any intermediate gearing in the metered water. This results in a very reliable design able to withstand most types of potable water environments. Ease of read in the toughest humid environments (ie: flooded pits) is secured by orientable hermetically sealed register (copper can/mineral glass envelope).

## Communication Device

Pre-equipped for communication through Cyble.

### Retrofit

Woltmag M mechanisms are different according to the body they will be installed in. Please check before ordering if the size of the meter is indicated in the arrow on the body (old generation and specific length) or not (new generation, from year 2000).

### WORKING PRINCIPLE

Woltmag M is a vertical Woltmann technology meter, constituted by:

- » Its body 1 made of cast iron or steel (high pressure variants) and protected against corrosion by an epoxy coating. The shape of the body integrates a flow straightener 2 that preserve metrology from flow disturbances.
- » Its extractable and interchangeable mechanism. The hermetically sealed copper can/mineral glass register 3 allows easy reading in any condition.

The direct magnetic transmission 4, with no gear in the water, allows the use of the meter in slightly loaded water. The shape of the measuring chamber 6 conforms the flow before it hits the helix 5.

The upper pivot 7, made of sapphire and cobalt tungsten carbide parts, give to the meter its capacity to withstand high flow rates, keeping metrological performances safe.

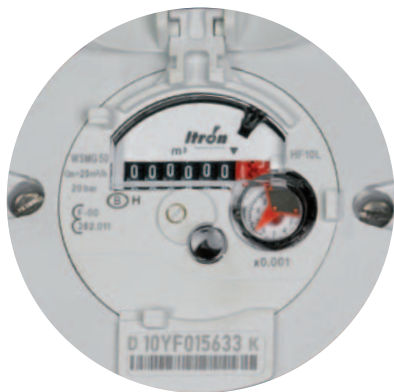

Woltmag M indicator

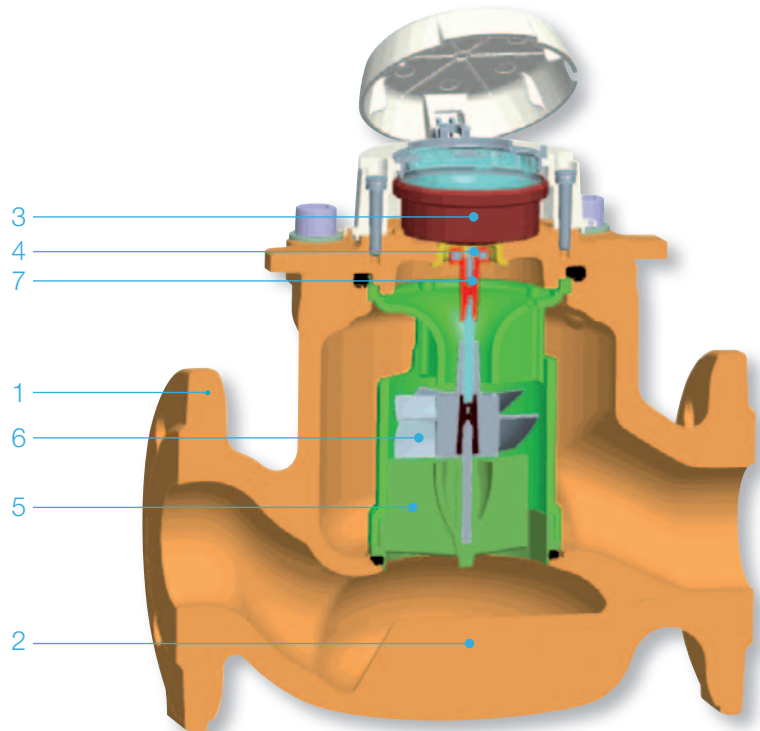

Cyble RF fitted on Woltmag M indicator, with specific lid

### COMMUNICATION

#### Woltmag M is supplied pre-equipped with Cyble Target

Allows communication and remote reading through:

- » Pulse output (Cyble Sensor)
- » M-Bus protocol (Cyble M-Bus)
- » Radio frequency wireless link (Cyble RF)

These Cyble modules enables the Woltmag M meter to be connected with various associated systems if and when desired.

They are particularly adapted to commercial and industrial applications where a need for frequent meter monitoring is expressed, especially in hard-to-read locations.

## METROLOGICAL CHARACTERISTICS

### Performance Values

Nominal diameter (DN)	mm	50		60/65		80		100	
	inches	2"		2" 1/2		3"		4"	
Type (according to Qn)	Wolmag M	N	G	N	G	N	G	N	G
Capacity 24h/day	m³/h	25		40		50		75	
Accuracy ± 2% from*	m³/h	40		60		75		115	
Starting flow	L/h	80		100		100		250	
Peak flow for a few minutes	m³/h	80		120		130		200	
Pressure loss at Qmax	bar	0.29	0.83	0.28	0.61	0.5	0.76	0.61	0.99
Maximum pressure	bar	20							
Maximum temperature	°C	50							
Indication range	m³	999999.99							
Minimum scale interval	L	0.5							
Cycle HF pulse weight	L	10							

### Performance Values

Nominal diameter (DN)	mm	50		60/65		80		100	
	inches	2"		2" 1/2		3"		4"	
Type (according to Qn)	Wolmag M	N	G	N	G	N	G	N	G
ISO 4064-1:1993 Class B horizontal position									
Nominal flow rate Qn	m³/h	15	25	25	40	40	50	60	75
Maximum flow rate Qmax	m³/h	30	50	50	80	80	100	120	150
Transitional flow rate Qt	m³/h	3	5	5	8	8	10	12	15
Minimum flow rate Qmin	m³/h	0.45	0.75	0.75	1.2	1.2	1.5	1.8	2.25
Pressure loss group	bar	0.6	1	0.3	1	0.6	1	1	1

### TYPICAL ACCURACY CURVE

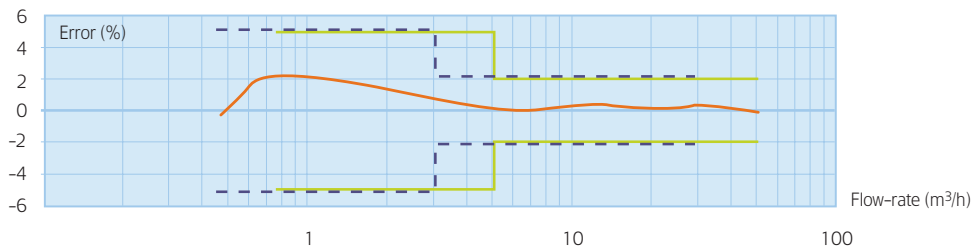

- Typical Wolmag M curve
- - - Wolmag N Type curve
- Wolmag G Type curve

### DOUBLE APPROVAL OF WOLTMAG M: QMAX VALUES

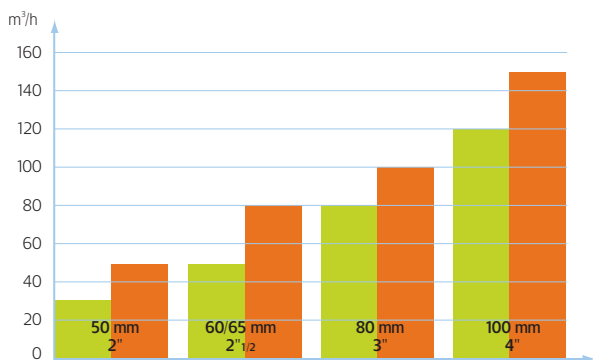

- Wolmag type N
- Wolmag type G

## Dimensions

	Nominal diameter (DN)	mm	50	60/65	80	100
			inches	2"	2" ½	3"
A	Standard	mm	250	300	350	400
		DIN	270	-	300	360
B		mm	125	150	175	200
C		mm	125	150	175	200
D		mm	77.5	98	99	105.5
E		mm	184.5	225	225	259.5
F		mm	262	323	324	365
G		mm	165	185	200	228
H		mm	302.5	381	381	446
Weight (meter)		kg	14.5	24.8	28	40.2
Weight (mechanism)		kg	3	5	5	6.6

\* "ISO Long" on request (DN50 = 300 mm, DN100 = 350 mm) / H = minimum height for mechanism removal.

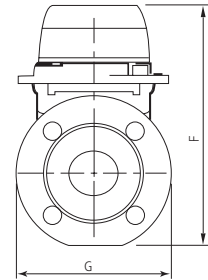
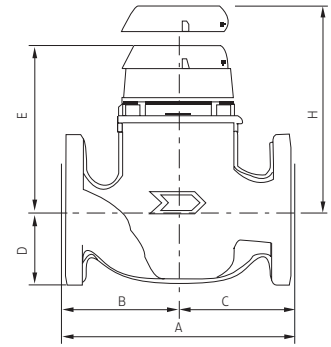

Dimensions

## HEAD LOSS

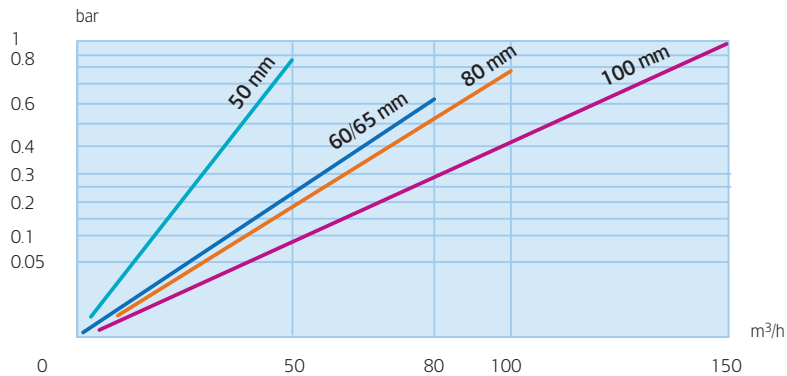

## INSTALLATION REQUIREMENTS

- » Woltmag M is a Class B horizontal meter (register facing upwards).
- » Woltmag M meters must be installed at the lowest point of the pipework in order to avoid the risk of trapped air in the meter. Water flow direction is indicated by the arrow stamped on the meter body.
- » We recommend the installation of a filter upstream of the meter to protect the mechanism from heavy water loads.



Our company is the world's leading provider of smart metering, data collection and utility software systems, with over 8,000 utilities worldwide relying on our technology to optimize the delivery and use of energy and water.

To realize your smarter energy and water future, start here: [www.itron.com](http://www.itron.com)

For more information, contact your local sales representative or agency:

**ITRON WATER METERING**